

## 1. Part No. Expression

**SPA252010FA R24 M**

(a)        (b)        (c)    (d)    (e)

- (a) Series Code
- (b) Dimension Code
- (c) Material Code
- (d) Inductance Code
- (e) Tolerance Code

## 2. Configuration & Dimensions (Unit: mm)

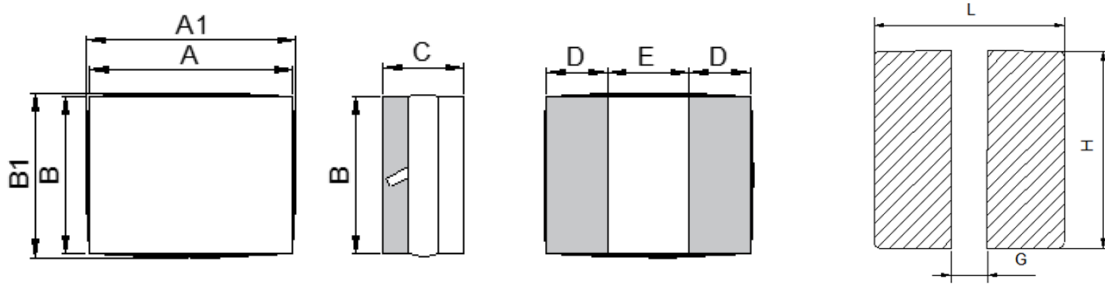

Recommended PCB Layout

Note: 1. The above PCB layout reference only.

A	A1	B	B1	C
2.50+0.20/-0.10	2.80 Max	2.00+0.20/-0.10	2.30 Max	1.00 Max
D	E	L	G	H
0.75 Ref	1.00 Ref	2.90 Ref	1.00 Ref	2.40 Ref

NOTE: Specifications subject to change without notice. Please check our website for latest information.

## 3. Material List

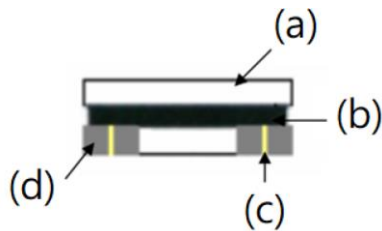

- (a) Core
- (b) Glue
- (c) Wire
- (d) Terminal

Void appearance tolerance limit & size of voids occurring to coating resin is specified below.

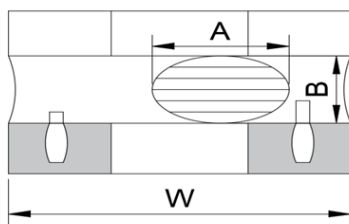

Exposed wire tolerance limit of coating resin part on product side.

Size of exposed wire occurring to coating resin is specified below:

1. Width direction (dimension a) : Acceptable when  $a \leq w/2$ ;  
Nonconforming when  $a > w/2$
2. Length direction (dimension b): Dimension b is not specified
3. The total area of exposed wire occurring to each side is not greater than 50% of coating resin area and is acceptable

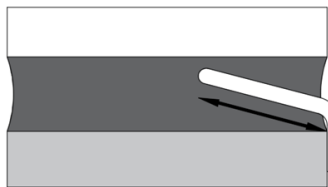

External appearance criterion for exposed wire.

Exposed end of the winding wire at the secondary side should be 2mm and below.

## 4. General Specifications

- (a) Operating Temp.: -40°C to +125°C (including self-temperature rise)
- (b) Storage Temp.: -40°C to +125°C (on board)
- (c) All test data referenced to 25°C ambient.
- (d) Heat Rated Current (Irms) will cause the coil temperature rise approximately  $\Delta T$  of 40°C.
- (e) Saturation Current (Isat) will cause inductance L0 to drop approximately 30%.
- (f) Rated Current: The lower value of Isat and Irms.
- (g) Storage Condition (Component in its packaging)
  - i) Temperature: Less than 40°C
  - ii) Humidity: Less than 60% RH

**NOTE:** Specifications subject to change without notice. Please check our website for latest information.

## 5. Electrical Characteristics

Part Number	Inductance ( $\mu\text{H}$ ) @0A $\pm 20\%$	Test Frequency	DCR ( $\Omega$ )		Isat (A)		Irms (A)	
			Typ	Max	Typ	Max	Typ	Max
SPA252010FAR24M	0.24	1V/1MHz	0.018	0.022	9.50	8.00	5.50 (1) 6.00 (2)	5.00 (1) 5.50 (2)
SPA252010FAR33M	0.33	1V/1MHz	0.023	0.028	8.00	6.50	5.30 (1) 5.60 (2)	4.80 (1) 5.10 (2)
SPA252010FAR47M	0.47	1V/1MHz	0.027	0.035	7.00	5.90	4.60 (1) 5.30 (2)	4.20 (1) 4.80 (2)
SPA252010FAR68M	0.68	1V/1MHz	0.032	0.040	5.50	4.60	4.20 (1) 4.40 (2)	3.80 (1) 4.00 (2)
SPA252010FA1R0M	1.0	1V/1MHz	0.044	0.053	4.90	4.30	3.50 (1) 3.70 (2)	3.10 (1) 3.40 (2)
SPA252010FA1R5M	1.5	1V/1MHz	0.062	0.074	3.80	3.10	3.20 (1) 3.40 (2)	2.80 (1) 3.00 (2)
SPA252010FA2R2M	2.2	1V/1MHz	0.078	0.093	2.80	2.30	2.60 (1) 2.80 (2)	2.30 (1) 2.50 (2)
SPA252010FA4R7M	4.7	1V/1MHz	0.180	0.216	1.70	1.40	1.70 (1) 1.80 (2)	1.50 (1) 1.60 (2)

Note:

Tolerance:  $M = \pm 20\%$

For Irms (A) Max. values with '(1)' or '(2)', refer to notes below for board test conditions.

Irms Max. board test conditions:

Irms (1)

Material: FR4

Board dimensions: 100 X 50 X 1.6t mm

Pattern dimensions: 45 X 30 mm (Double side board)

Pattern thickness: 50  $\mu\text{m}$

Irms (2)

Material: FR4

Board dimensions: 100 X 50 X 1.6t mm

Pattern dimensions: 45 X 45 mm (Double side board)

Pattern thickness: 70  $\mu\text{m}$

NOTE: Specifications subject to change without notice. Please check our website for latest information.

## 6. Characteristics Curve

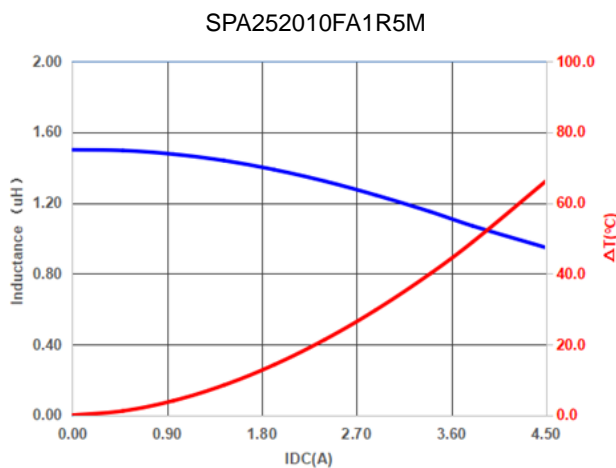
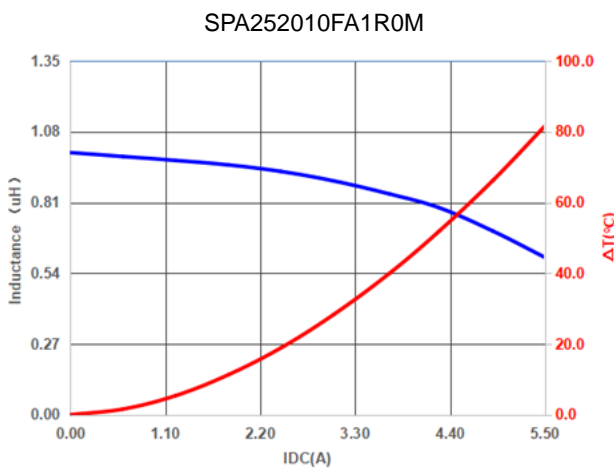
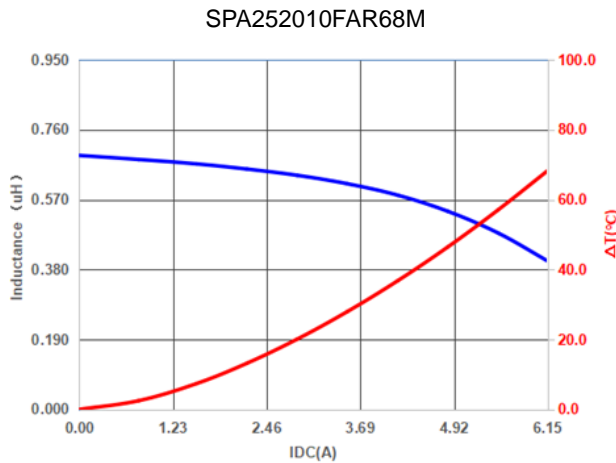
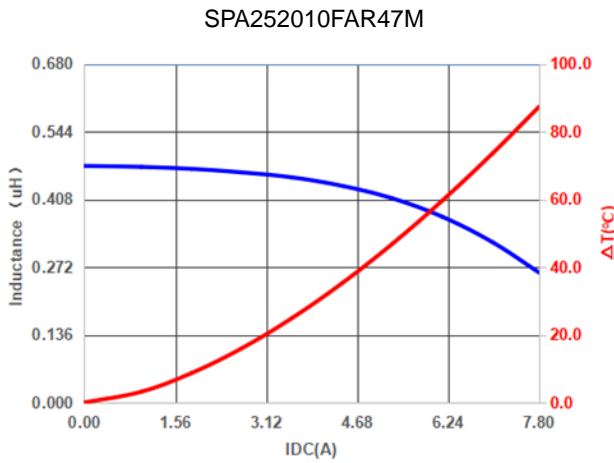
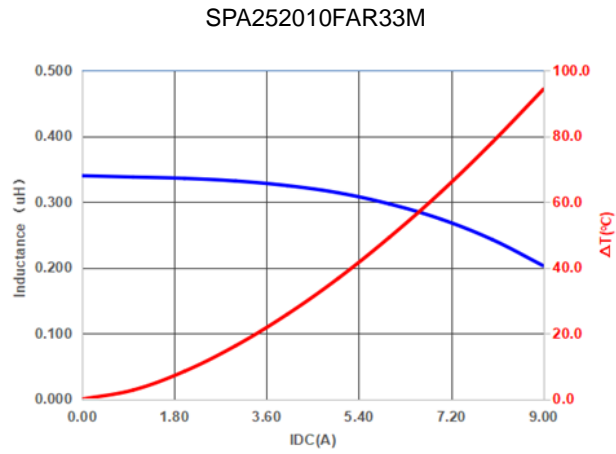
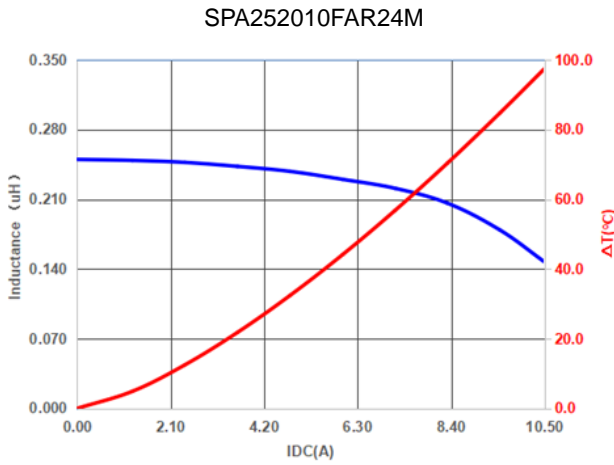

NOTE: Specifications subject to change without notice. Please check our website for latest information.

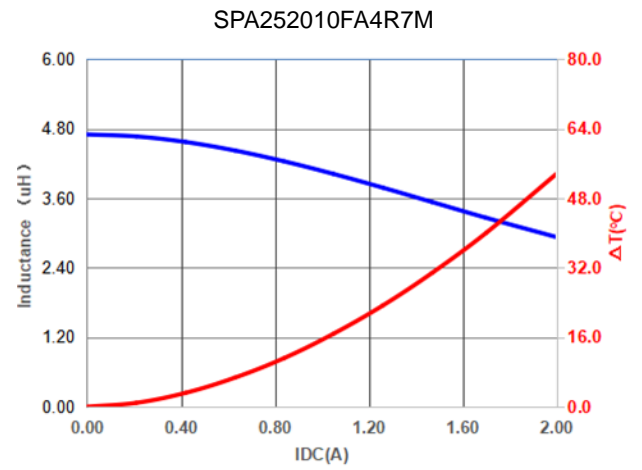
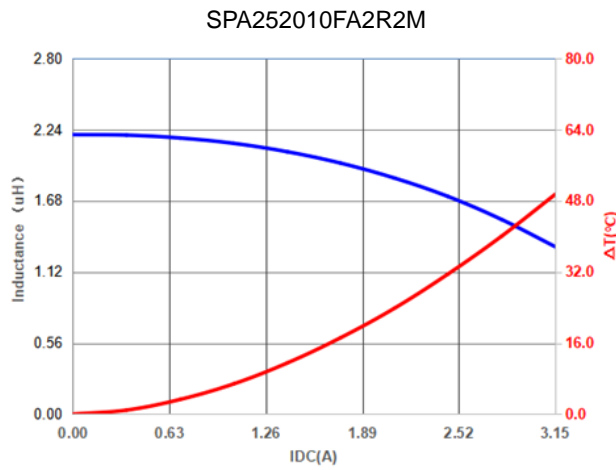

NOTE: Specifications subject to change without notice. Please check our website for latest information.

**7. Soldering Specification**

Mildly activated rosin fluxes are preferred. Our terminations are suitable for re-flow soldering systems. If hand soldering cannot be avoided, the preferred technique is the utilization of hot air soldering tools.

**7-1. IR Soldering Reflow**

Recommended temperature profiles for lead free re-flow soldering in Figure 1, Table 1.1 & 1.2 (J-STD-020E).

**7-2. Iron Reflow**

Products attachment with a soldering iron is discouraged due to the inherent process control limitations. In the event that a soldering iron must be employed the following precautions are recommended (Figure 2).

Note:

- (a) Preheat circuit and products to 150°C.
- (b) 355°C tip temperature (Max.)
- (c) Never contact the ceramic with the iron tip
- (d) 1.0mm tip diameter (Max.)
- (e) Use a 20 watt soldering iron with tip diameter of 1.0mm
- (f) Limit soldering time to 4~5 sec.

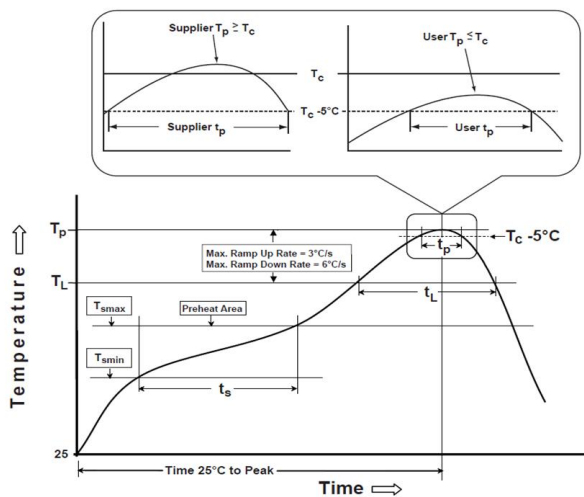

Reflow times: 3 times Max

Figure 1: IR Soldering Reflow

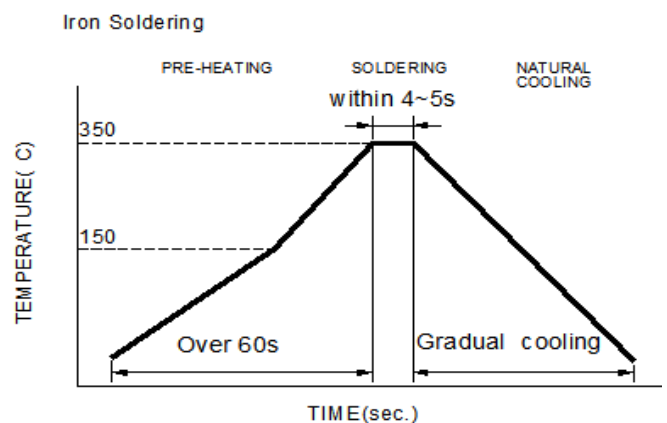

Iron Soldering times: 1 times max.

Soldering iron method: 350±5°C Max

Figure 2: Iron soldering temperature profiles

NOTE: Specifications subject to change without notice. Please check our website for latest information.

**Table (1.1) Reflow Profiles**

Profile Type:	Pb-Free Assembly
Preheat	
-Temperature Min ( $T_{smin}$ )	150°C
-Temperature Max ( $T_{smax}$ )	200°C
-Time ( $t_s$ ) from ( $T_{smin}$ to $T_{smax}$ )	60-120seconds
Ramp-up rate ( $T_L$ to $T_p$ )	3°C /second max.
Liquids temperature ( $T_L$ )	217°C
Time ( $t_L$ ) maintained above $T_L$	60-150 seconds
Classification temperature ( $T_c$ )	See Table (1.2)
Time ( $t_p$ ) at $T_c - 5^\circ\text{C}$ ( $T_p$ should be equal to or less than $T_c$ .)	* < 30 seconds
Ramp-down rate ( $T_p$ to $T_L$ )	6°C /second max.
Time 25°C to peak temperature	8 minutes max.

**T<sub>p</sub>**: maximum peak package body temperature, **T<sub>c</sub>**: the classification temperature.

For user (customer) **T<sub>p</sub>** should be equal to or less than **T<sub>c</sub>**.

\*Tolerance for peak profile temperature ( $T_p$ ) is defined as a supplier minimum and a user maximum.

**Table (1.2) Package Thickness/Volume and Classification Temperature ( $T_c$ )**

	Package Thickness	Volume mm <sup>3</sup> <350	Volume mm <sup>3</sup> 350-2000	Volume mm <sup>3</sup> >2000
PB-Free Assembly	<1.6mm	260°C	260°C	260°C
	1.6-2.5mm	260°C	250°C	245°C
	≥2.5mm	250°C	245°C	245°C

Reflow is referred to standard IPC/JEDEC J-STD-020E.

NOTE: Specifications subject to change without notice. Please check our website for latest information.

## 8. Packaging Information

### 8-1. Reel Dimension (Unit: mm)

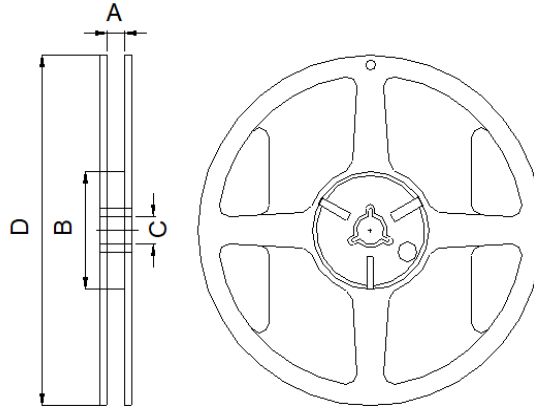

Type	A	B	C	D
7"X8mm	8.4±1.0	50.0 Min	13.0±0.8	178.0±2.0

### 8-2. Tape Dimension (Unit: mm)

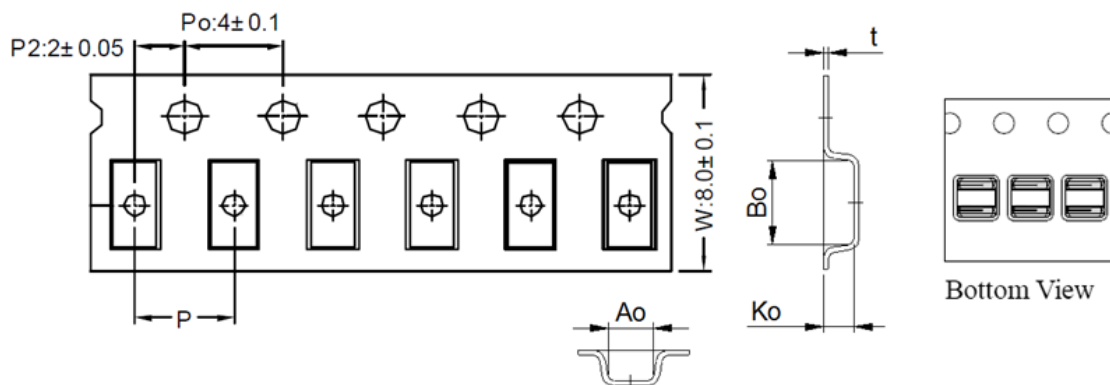

Bo	Ao	Ko	P	t
3.10±0.10	2.45±0.10	1.40±0.10	4.00±0.10	0.23±0.05

NOTE: Specifications subject to change without notice. Please check our website for latest information.



### 8-3. Packaging Quantity (Unit: Pcs)

Chip/ Reel	2,000
------------	-------

### 8-4. Tearing Off Force

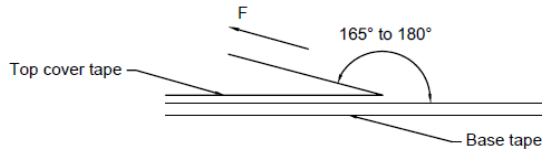

The force for tearing off cover tape is according to the follow table, in the arrow direction under the following conditions.

(Referenced ANSI/EIA-481-D-2008 of 4.11 standard)

Room Temp. (°C)	Room Humidity (%)	Room atm (hPa)	Tearing Speed (mm/min)
5~35	45~85	860~1060	300±10

Tape Size	8 mm	12 to 56 mm	72 mm or Wider
Tearing Off Force (grams)	10~100	10~130	10~150

## Application Notice

#### 1. Storage Conditions

To maintain the solderability of terminal electrodes:

- (a) Recommended products should be used within 12 months from the time of delivery.
- (b) The packaging material should be kept where no chlorine or sulfur exists in the air.

#### 2. Transportation

- (a) Products should be handled with care to avoid damage or contamination from perspiration and skin oils.
- (b) Vacuum pick up is strongly recommended for individual components.
- (c) Bulk handling should ensure that abrasion and mechanical shock are minimized.

**NOTE:** Specifications subject to change without notice. Please check our website for latest information.